

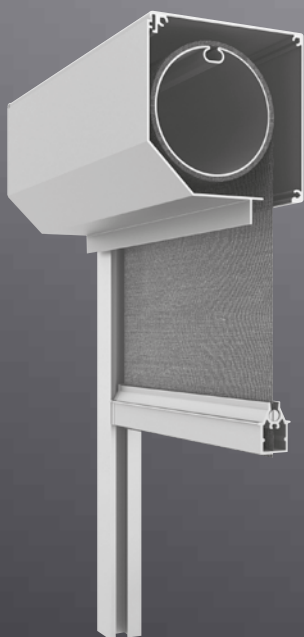

Screens

Screen



Een klassieke screenoplossing om uw huis en kantoor tegen de zon te beschermen.

Deze standaard screen onderscheidt zich door een kast met zijgeleiders, doek gemaakt van glasvezel en PVC, die duurzaam en bestand is tegen weersomstandigheden zoals windstoten, hagel of regen. Door de eigenschappen van de doeken kan de warmte worden buiten gelaten zonder dat het helemaal donker wordt. We bieden een breed scala aan vormen en kleuren van kasten en geleiders aan, evenals een breed scala aan doeken waardoor er altijd iets voor u tussen zit.

Screen 75

Screen 75

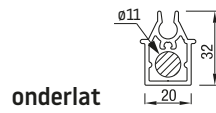
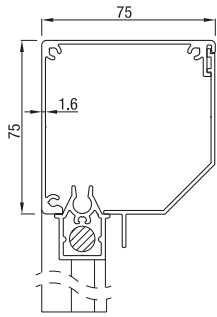

	Maximale breedte (cm)	hoogte (cm)	oppervlak (m ²)
Screen 75	350	230	5,8

Screen 85

Screen 85 schuin

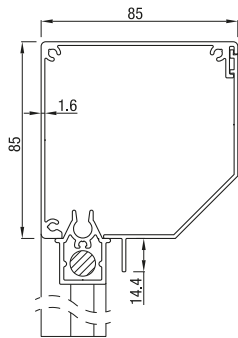

Screen 85 halfrond

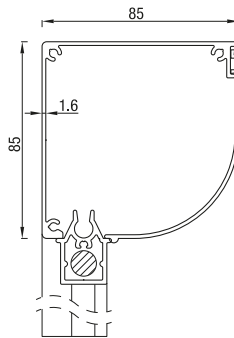

Screen 85 recht

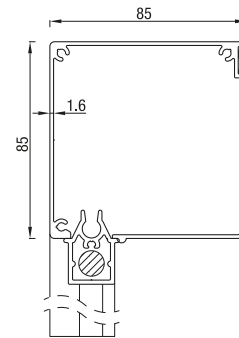

onderlat

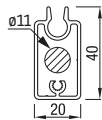
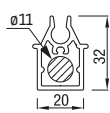

	Maximale breedte (cm)	hoogte (cm)	oppervlak (m ²)
Screen 85	350	320	8,0

Screen 95

Screen 95 schuin

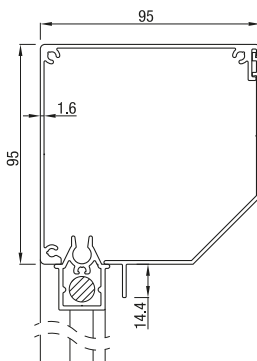

Screen 95 recht

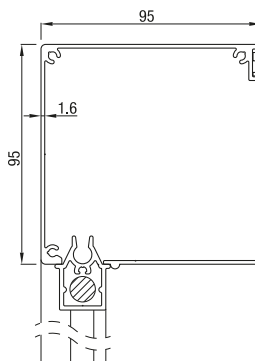

onderlat

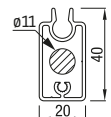
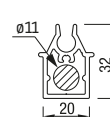

	Maximale breedte (cm)	hoogte (cm)	oppervlak (m ²)
Screen 95	400	340	9,8

Screen 105

Screen 105 schuin

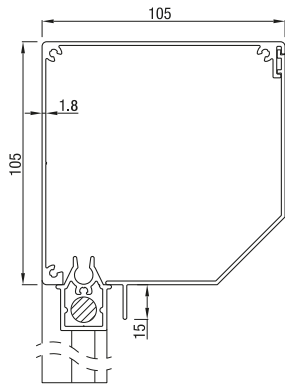

Screen 105 recht

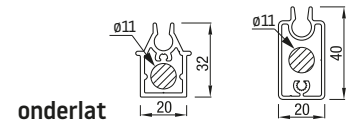
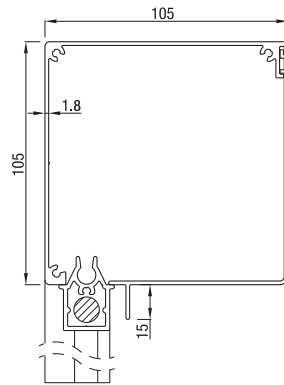

onderlat

	Maximale breedte (cm)	hoogte (cm)	oppervlak (m ²)
Screen 105	400	320	12,8

Screen 120

Screen 120 half rond

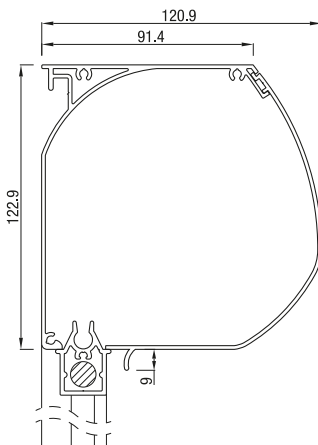

Screen 120 dicht

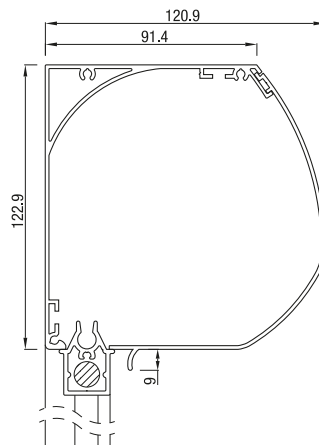

Screen 125 schuin

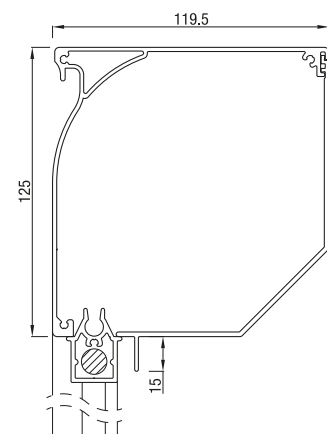

Screen 125 recht

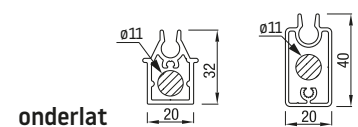
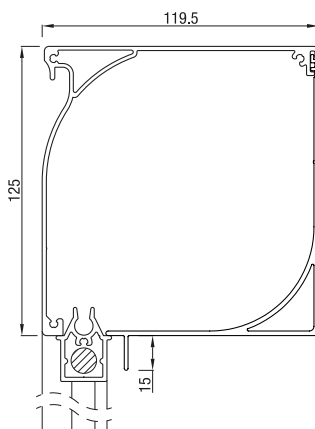

onderlat

	Maximale breedte (cm)	hoogte (cm)	oppervlak (m ²)
Screen 125	500	500	17,1

Geleiders

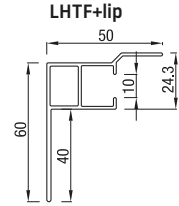
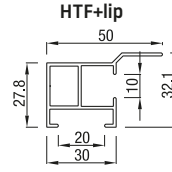
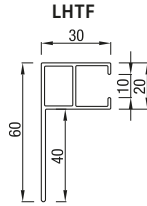
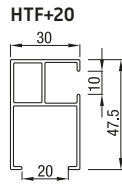
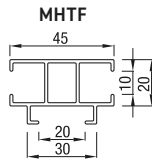
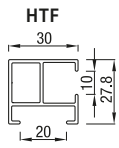

Standaard omkasting Screen

kleur dichtst bij RAL*



RAL 9001
Crémewit



RAL 9010
Wit

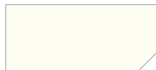

RAL 9016
Verkeerswit



RAL 1015
Ivoor



Technisch Zilver
(Geanodiseerd)



RAL 9006
Blank aluminium



RAL 7016
Antracietgrijs



RAL 6009
Tannengroen



RAL 5011
Staalblauw



Tiger 29/80081
Iron Glimmer (structuurlak)

	RAL 9001 Crémewit	RAL 9010 Wit	RAL 9016 Verkeerswit	RAL 1015 Ivoor	Technisch Zilver	RAL 9006 Blank aluminium	RAL 7016 Antracietgrijs	RAL 6009 Tannengroen	RAL 5011 Staalblauw	Tiger 29/80081
Screen 75	•	•			•					
Screen 85 schuin	•	•	•	•	•	•	•	•	•	•
Screen 85 half rond	•	•			•	•				
Screen 85 recht	•	•			•	•				
Screen 95 schuin	•	•	•	•	•	•	•	•	•	•
Screen 95 recht	•	•			•	•				
Screen 105 schuin	•	•	•	•	•	•	•	•	•	•
Screen 105 recht	•	•			•	•				
Screen 120 half rond	•	•	•	•	•	•	•	•	•	•
Screen 120 dicht	•	•	•	•	•	•	•	•	•	•
Screen 125 schuin	•	•	•	•	•	•	•	•	•	•
Screen 125 recht	•	•			•	•				

somfy

Serge Ferrari
COMPOSITE TEXTILES FOR LIGHTNESS

helioscreen

MERMET
SUN CONTROL TEXTILES

copaco
screenweavers

DICKSON
Innovative Solutions for your world

01/2020

EXCELSIOR
Zonwering sinds 1930



Excelsior Zonwering BV
Tt. Vasumweg 26 (NDSM terrein)
1033 SC, Amsterdam
020 - 6920 388

www.excelsiorzonwering.nl